

10

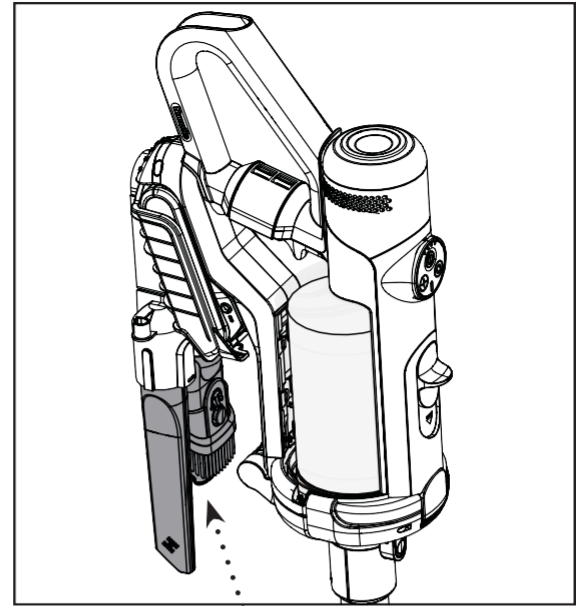

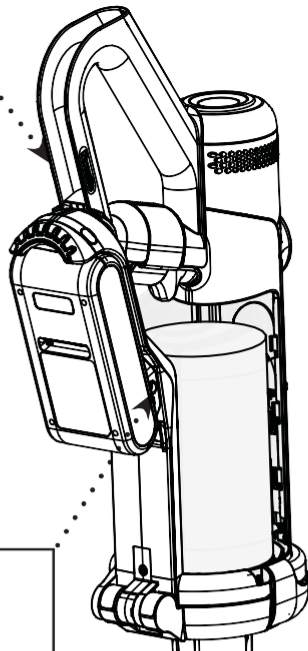

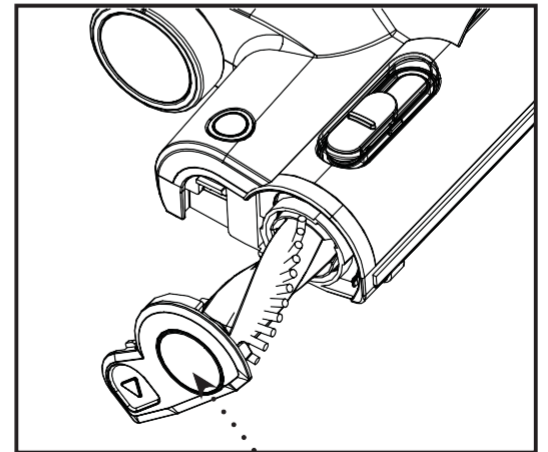
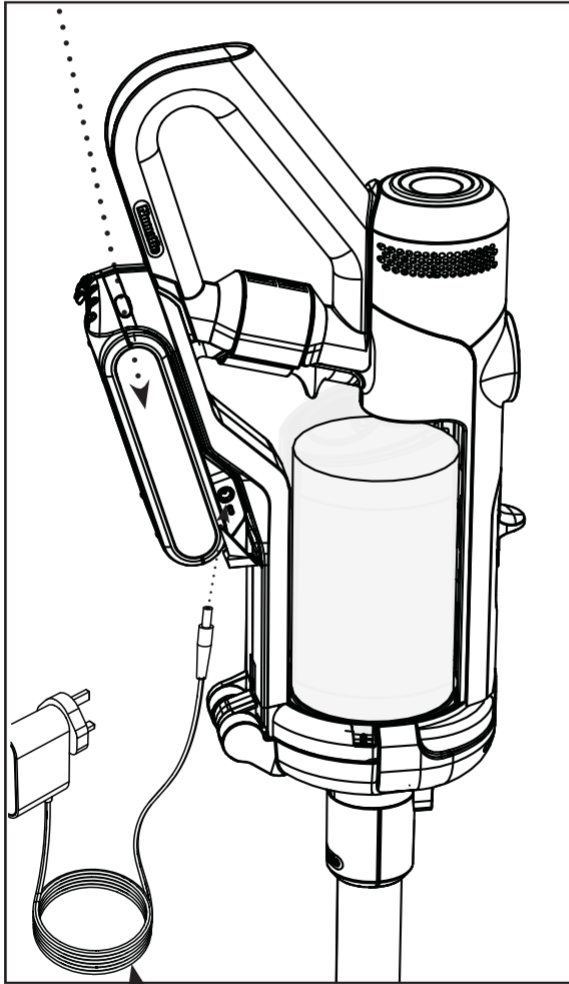

9

8

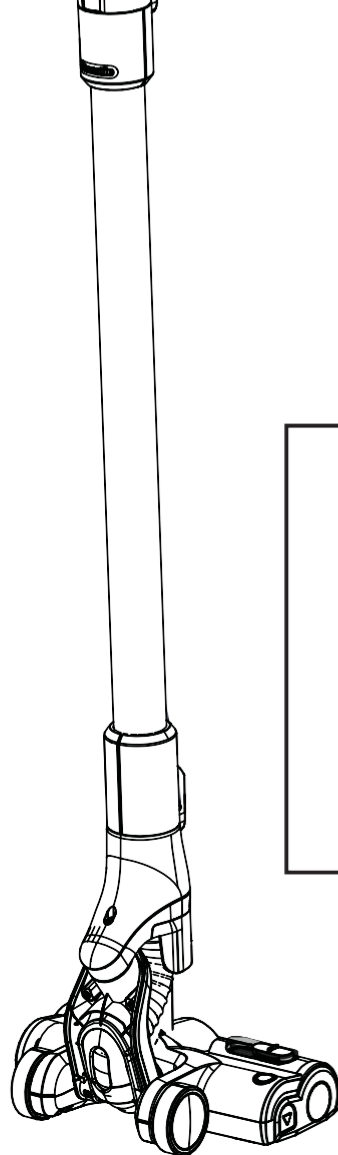



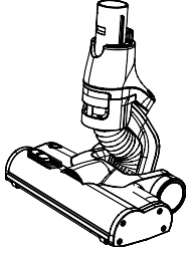



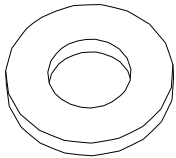
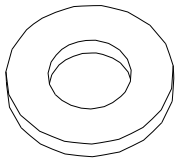
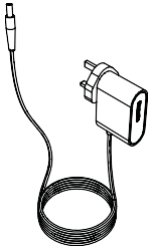

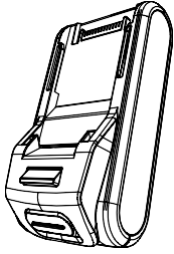
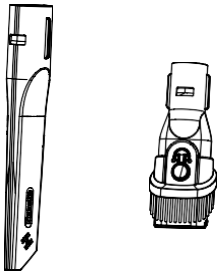
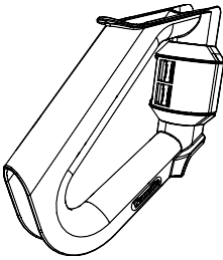
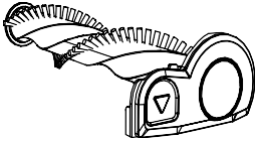

11



Item Number	Image Reference	Item Description	Part Number	Item Quantity
1		Stick Vac Pods (WW) (Pack of 10)	915269	1
2		NQ 100 Floor Tool (Graphite)	914744	1
3		Henry/ NQ 100 Wand (Graphite)	915356	1
4		Wall Mount	915351	1

Item Number	Image Reference	Item Description	Part Number	Item Quantity
5		Scent Pod Cap	915357	1
6		Rose Scent Pods (Pack of 10)	915674	1
6		Vanilla Scent Pods (Pack of 10)	914593	1
7		Battery Charger (AUS/NZ Plug)	915246	1

Item Number	Image Reference	Item Description	Part Number	Item Quantity
8		Spare Battery.25.2V	915170	1
9		Crevice & Combi Tool Pack	915352	1
10		Extension Handle	915353	1
11		Brushbar Including Cap	915358	1

	UK		<p>Any maintenance operation is to be carried out in a safe environment All electrical work is to be carried out by a competent person Move tank assembly Retain all nuts, screws and washers for refitting (If applicable)</p>	
	DE		<p>Sämtliche Wartungsarbeiten sind in einer sicheren Umgebung durchzuführen Alle Elektroarbeiten sind durch eine entsprechend befähigte Person durchzuführen Bewegen Sie die Tankbaugruppe Bewahren Sie alle Muttern, Schrauben und Unterlegscheiben zum Wiedereinbau sicher auf (falls zutreffend)</p>	
	ES		<p>Toda operación de mantenimiento debe realizarse en un entorno seguro Todo trabajo eléctrico debe ser realizado por una persona competente Mover el conjunto de depósito Guardar todas las tuercas, tornillos y arandelas para volver a colocarlos (si corresponde)</p>	
	FI		<p>Kaikki huoltotoimenpiteet on suoritettava turvallisessa ympäristössä Ammattitaitoisen henkilön on tehtävä kaikki sähkötyöt Siirrä säiliöyksikkö Säilytä kaikki mutterit, ruuvit ja prikat asennusta varten (jos käyttökelpoisia)</p>	
	FR		<p>Toute opération d'entretien doit être effectuée dans un environnement sécurisé Tous travaux électriques doivent être assurés par du personnel qualifié uniquement Déplacez l'ensemble réservoir Conservez tous les écrous, vis et rondelles en vue d'un (éventuel) remplacement</p>	
	IT		<p>Tutti gli interventi di manutenzione devono essere effettuati in un ambiente sicuro Tutti gli interventi elettrici devono essere effettuati da personale competente Spostamento del gruppo serbatoio Conservare tutti i dadi, le viti e le rondelle per il rimontaggio (se applicabile)</p>	
	NL		<p>Alle onderhoudswerkzaamheden moeten worden uitgevoerd in een veilige omgeving Alle elektrische werkzaamheden moeten worden uitgevoerd door een bevoegd persoon Verplaats de hoofdtank Bewaar alle moeren, schroeven en sluitringen voor hermontage (indien van toepassing)</p>	
	PL		<p>Wszystkie czynności konserwacyjne należy wykonywać w bezpiecznym środowisku Wszelkie prace elektryczne powinna wykonywać osoba kompetentna Przesunąć zespół zbiornika Zachować wszystkie nakrętki, śruby i podkładki do ponownego montażu (jeżeli dotyczy)</p>	
	PT		<p>Qualquer operação de manutenção deve realizar-se num ambiente seguro Todo o trabalho elétrico deve ser realizado por um técnico qualificado Mover o depósito principal Guardar todas as porcas, parafusos e anilhas para reinstalar (se aplicável)</p>	
	SV		<p>Alla former av underhåll ska utföras i en säker miljö Allt elektriskt arbete ska utföras av en behörig person Flytta tankenheten Behåll alla muttrar, skruvar och brickor för reparation (om det är tillämpligt)</p>	

